

Balun Panel, 75/120W, 2-8Mbit/s, E1 & E2, Shielded 19" 1RU, 16x1.6/5.6 (f) to 8xRJ45 (f)

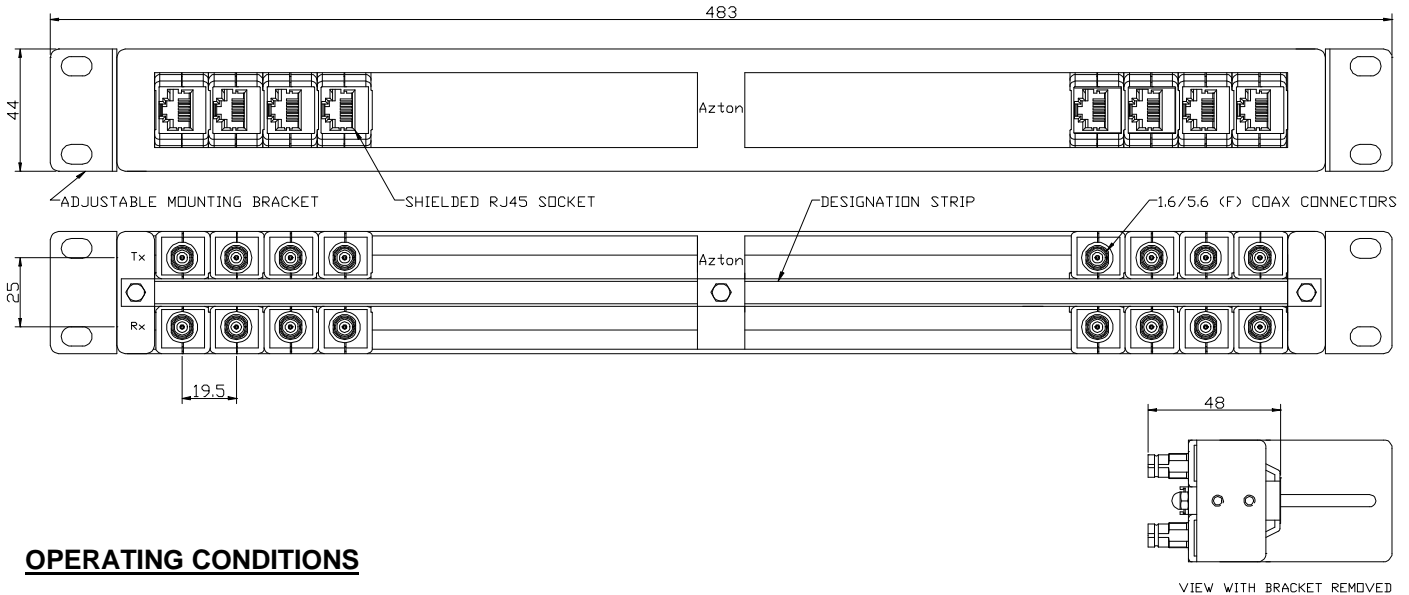

OPERATING CONDITIONS

Matching Impedance: 75 ohm unbalanced coaxial to 120 ohm balanced twisted pair
 Bit Rate: 2Mbit/s (E1) and 8Mbit/s (E2) per ITU-T G.703 Line Code
 Signal Level: 2.37V nominal peak voltage at the coaxial end per G.703
 Working Temperature: -30°C to 75°C

ELECTRICAL SPECIFICATIONS

Insertion Loss: < 0.15dB from 51kHz to 3.072MHz (2Mbit/s, E1) and < 0.20dB from 211kHz to 12.673MHz (8Mbit/s, E2) in both directions
 Return Loss: Exceeds G.703 requirements by >13dB for 2Mbit/s and >8dB for 8Mbit/s
 Pulse Shape: Exceeds G.703 requirements for 2Mbit/s and 8Mbit/s
 Cross Talk: < -70dB from 51kHz to 12.673MHz between channels
 Isolation Voltage: > 250V DC for 1 minute

MECHANICAL SPECIFICATIONS

Coaxial Connector: 1.6/5.6 female to IEC 169-13
 Body: Brass, Plated Cu/Ni5/Au0.8
 Pin: Beryllium Copper, Plated Cu/Ni5/Au1.25
 Insulator: Teflon
 Mating Cycles: 500min
RJ45 Connector: Contacts: Phosphor Bronze, Plated Ni/Au
 Moulding: PBT Glass Filled, Black
 Shield: Brass, Plated Sn
Mouldings: ABS-PC, Black
Panel: Steel, Zinc Sealed and Powder Coated Black

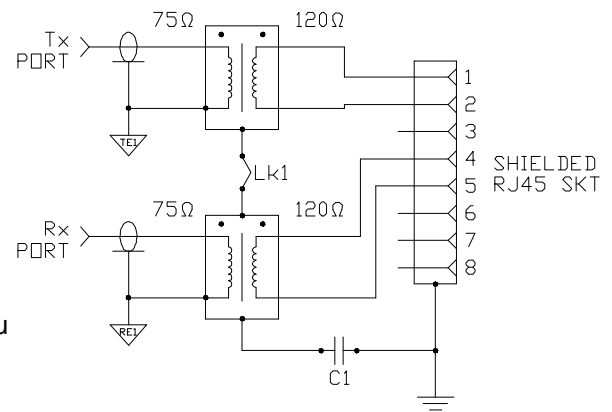

ACCESSORIES

Mounting Brackets: For 21" and 23" racks
 Dual Balun Modules: For alternative coax connectors, bit rates or expansion up to 20 channels